

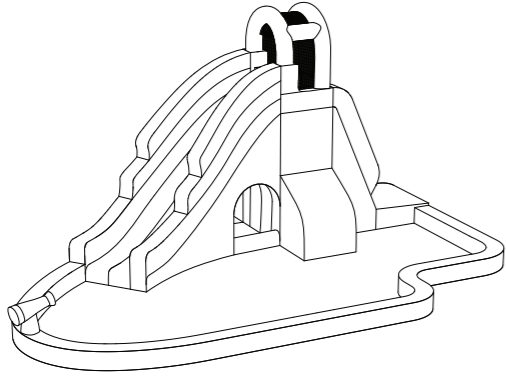

INFLATABLE WATER PARK USER GUIDE

SFWTR862



Thank you for purchasing the Sunny & Fun Inflatable Water Park. This User Guide is intended to provide you with guidelines to ensure that operation of this product is safe and does not pose risk to the user. Any use that does not conform to the guidelines described in this User Guide may void the limited warranty.

Please read all directions before using the product and retain this guide for reference. This product is intended for outdoor use.

This product is covered by a limited one-year warranty. Coverage is subject to limits and exclusions. See warranty for details.

Box Contents

- A. Inflatable Water Park
- B. Air pump
- C. Carrying case
- D. Repair kit
- E. 4 Air pump stakes
- F. 8 Water park stakes
- G. 1 Hose assembly kit
- H. 1 Hose connector
- I. 1 Storage strap

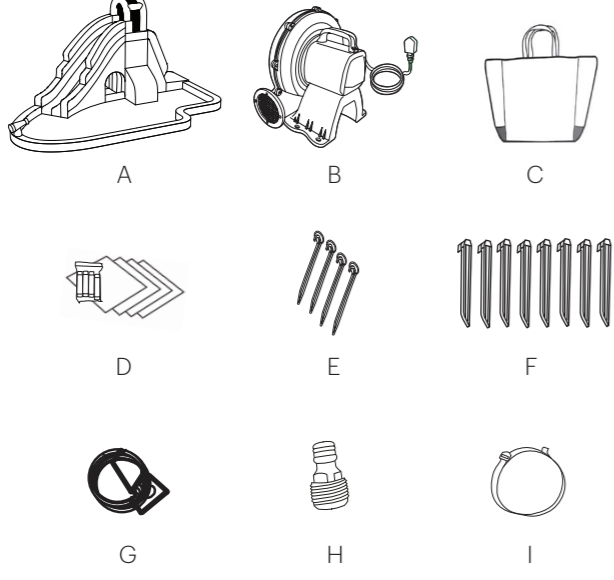

Safety Precautions

WARNING FAILURE TO FOLLOW THESE INSTRUCTIONS COULD RESULT IN SERIOUS INJURY OR DEATH.

CAUTION ELECTRICALLY OPERATED PRODUCT Do not allow children to operate the air pump. As with all electric products, precautions should be observed during handling and use to prevent electric shock.

- Do not use extension cords with this product.
- This product is intended for outdoor use only.
- Read all instructions before assembling this inflatable device. Keep instructions for future use.

WARNING ELECTROCUTION RISK:
- KEEP ALL ELECTRICAL LINES, RADIOS, SPEAKERS AND OTHER ELECTRICAL DEVICES AWAY FROM THE PRODUCT.
- DO NOT PLACE THE PRODUCT NEAR OR UNDER OVERHEAD ELECTRICAL LINES.

- Children (especially toddlers) are at high risk of drowning. Closely watch children who are in or near this inflatable device. Empty inflatable device or prevent access when not in use.
- **ADULT SUPERVISION AND SETUP REQUIRED. This product should be inflated or deflated only by a competent adult. Follow all instructions provided.**
- **WARNING! Falls onto hard surfaces can result in head or other serious injuries. Never place product on concrete, asphalt, wood, packed earth, or other hard surfaces. Carpet over hard surfaces may not prevent injury.**
- **WARNING! For domestic use only.** Intended for outdoor domestic family use only. Not for use in public areas or as a rental.
- Product is heavy. Use caution when lifting.
- Product should never be dragged across concrete, pavement or other rough surfaces.
- **WARNING!** Keep away from fire. Keep fabric clear of all flame and ignition sources.
- Do not set up in windy or rainy conditions; sudden gusts of wind may lift the product off of the ground.
- Set up only in outdoor locations that meet the following criteria:
 - Place on level ground and firm grass or soil to allow proper use of stakes.
 - Placing on slanted or uneven surfaces may cause the product to tip.
 - Stakes should be placed at an angle for better anchorage, and should penetrate the ground to prevent tripping.
 - Minimum clearance zones: place at least 6.5 ft. (2m) away from any other objects.
 - Objects to be avoided include but are not limited to fences, buildings, trees, overhead branches, laundry lines, electrical wires, walls, or bodies of water.
 - Make sure the area around the product is secure by adding safety barriers, if necessary, to keep young children and pets from gaining access.
- Make sure that the power cord does not pass under the air-filled water park, as this could interfere with its operation.
- The water park uses a main powered air pump to maintain pressure, only to be used by an adult.
- Only the air pump supplied should be used for inflation.
- Do not use extension cords with this product. Set up as close to power source as possible.
- The air pump should be securely anchored to the ground before use.
- **CAUTION:** The air pump is capable of moving large volumes of air very quickly. Place the air pump in an area where it will not draw in dirt or leaves. Keep blower and power cord away from children, water, and traffic.
- **ATTENTION:** The air pump should remain on and continuously inflate the water park during use. Airflow through seams is normal.
- Do not use the product if wind speed exceeds 18.6 mi/h (30km/h).
- Do not consume food, drinks, or gum while using this product.
- Constant, competent adult supervision of children and other young users is required at all times.
- Keep the area around the product clean and clear of objects to prevent slips and falls.
- Instruct children on proper use of this product. Do not use in a manner other than intended.
- Helmets, headgear, shoes, glasses, loose clothing, scarves, hoods, or clothing containing drawstrings should not be worn when using this product.
- Do not allow other toys or objects inside the product.
- Instruct children not to attach items to the product that are not specifically designed for use with the equipment, such as but not limited to jump ropes, clotheslines, pet leashes, cables, and chains, as they may pose a strangulation hazard.
- Keep pets away from the product.
- Bounce away from others and stay away from side walls, especially the opening.
- Do not jump onto or off of the product.
- Do not allow children who are unequally matched in weight and size to play together on the product.
- The maximum fall height of the product is 56 in. (142cm).
- Maximum number of children playing on this product at one time must not exceed three (3) children.
- Total weight of children must not exceed 350 lbs. (159kg) on slide and pool.
- Do not allow more than one child at a time on each slide and climber.
- Children or pets must not slide down headfirst.
- Do not let children near the area where the air pump motor is attached.
- Always dry product before storage.
- Never use product as a floatation or lifesaving device.
- Children can drown in very small amounts of water. Empty the pool when not in use.
- Do not install the pool over concrete, asphalt or any other hard surface.
- Always check for excessive air loss, and re-inflate before allowing play to continue.
- As an outdoor product, this inflatable water park is subject to wear and deterioration. Keep product properly maintained and watch for signs of fabric failure.
- Weak or torn surfaces must be repaired promptly.
- If the water park contains a pool:
 - Never dive or jump into the pool area.
 - Do not sit on the edges of the pool as flooding may occur.
 - Do not allow children to slide into an unfilled pool. Fill the pool with water before allowing children to access the slide.
 - Always drain the water park after use. Do not leave it inflated or full of water overnight.
 - Keep the pool area clean to prevent illness. Instruct all children never to drink pool water and to practice good hygiene.
- Before and during use, check for air loss. Check that the air pump is properly connected.
- Always check the product and all its anchorage points before and during use, and re-secure as appropriate.
- If applicable, remove all water and debris from pocket steps after each play cycle.
- After inflation, the air pump should run continuously while children are playing.

- Make sure the product is not in use while it is being deflated.
 - Always deflate the product after use, and store it indoors.
 - The product should be periodically examined for potentially unsafe conditions such as: damaged cord, plug, housing, or parts, and that in the event such damage is found, the product should not be used until properly repaired.
 - Never leave the fan outside in the rain or elements when not in use. Refer to the instructions for setup, storage, maintenance, and care.
 - Change the water of the pool frequently (particularly in hot weather) or when noticeably contaminated.
 - The water park can be installed in any orientation in relation to the sun, since there are no metal components or surfaces that can absorb excessive heat.
- Drowning Risk:**
- Keep unsupervised children from accessing the pool by installing fencing or other approved barriers around all sides of the water park.
 - State or local laws or codes may require fencing or other approved barriers. Check state or local laws and codes before setting up the water park.
 - Drowning occurs silently and quickly. Assign an adult to supervise children using the water park.
 - Keep children in your direct sight when they are in or near the water park and when you are filling and emptying it.
 - When searching for a missing child, check the pool first, even if you think your child is in the house.

First Aid:

- Keep a working phone and list of emergency numbers near the water park.
- It is recommended to be certified in cardiopulmonary resuscitation (CPR) so you can respond to an emergency.

WARNING FAILURE TO FOLLOW THESE INSTRUCTIONS COULD RESULT IN SERIOUS INJURY OR DEATH.



Choosing a Location

1. Designate a flat, level surface that allows for 6.5 ft. (2m) of minimum clearance around the water park.
- NOTE: DO NOT place the product on a hard surface like asphalt, concrete or packed earth, as this may result in damage and/or serious bodily injury.
2. Make sure the assembly area is flat and level and is free of rocks, sharp objects or other obstructions.
 3. Do not set up on a slope or incline.
 4. Once the product is inflated or filled with water, do not attempt to drag it to another location.

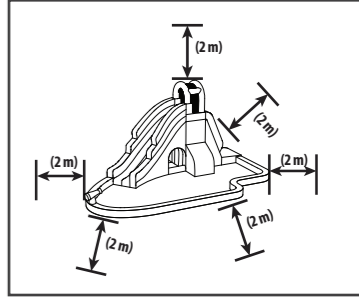

Staking the Water Park in Place

1. Secure the water park and the air pump to the ground with the provided stakes.

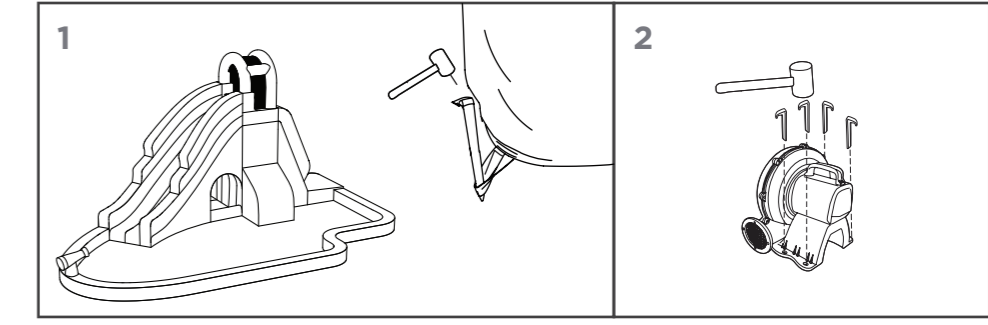

NOTE:

- To prevent tripping, pull the stake loops all the way out, then drive the stakes completely into the ground.
- Drive ground stakes completely into the ground to avoid tripping hazard.
- Do not use the product until an adult has assembled, staked down, and fully inflated it.
- Do not set up or inflate the product in windy and/or rainy conditions as wind gusts may cause the park to become unstable and possibly be lifted from the ground.

Setting Up the Water Park

1. Unroll and unfold the water park in the center of the area in which it will be used.
2. Attach the longer fabric tube to the air pump, making sure the tube is not twisted.
3. Wrap the drawstring around the tube and the end of the air pump once, and tie tightly in place.
4. Tie off the short air outlet tube tightly to make a good seal.

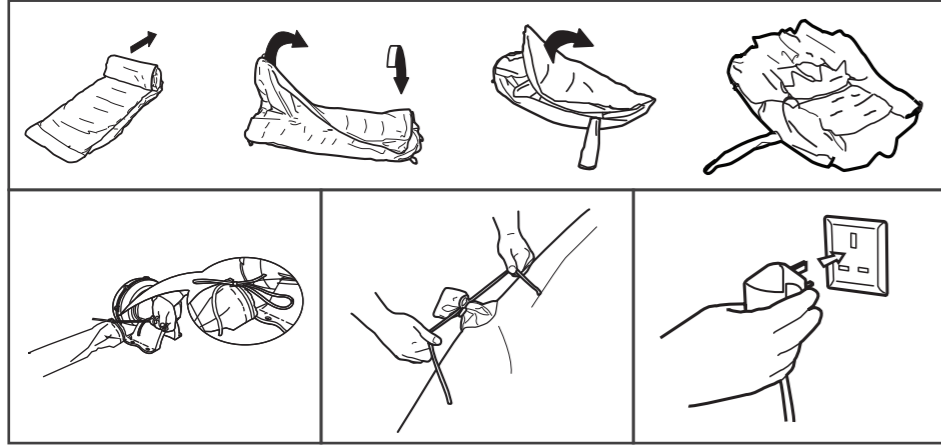

Setting Up the Air Pump

1. Make sure that the air pump switch is in the "OFF" position. Plug the air pump into a 110 V outlet.
2. Set the power switch of the air pump to "ON" to inflate.
3. After use, turn the power switch to "OFF".

NOTES: Always set up the air pump as close to the power source as possible. The product should be periodically examined for potentially unsafe conditions such as: damaged cord, plug, housing or parts, and that in the event such damage is found, the product should not be used until properly repaired.

Never leave the air pump outside in the rain or exposed to the elements when not in use. When in use, do not place the cord across traffic areas, water, or damp areas. The air pump should be placed on a stable surface and anchored per product instructions.

Using the Slide Sprayer

1. Turn on the garden hose and adjust the pressure as desired.
2. Make sure that a steady spray of water comes out of the sprayer and keeps the slides wet.

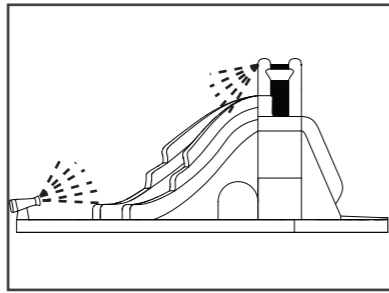

Playing on the Water Park

NOTE: It is normal to see air bubbles rising from the pool floor and other wet areas of the water park.

Using the slide

1. Climb up the climbing wall to the top of the slide.
2. Sit at the top of the slide with feet pointing down the slide.
3. Scoot forward and slide down into the splashdown area.
4. **DO NOT** slide down on your stomach or headfirst.

Draining and Deflation

NOTE: For best results, 2 - 4 people should drain and move the water park.

1. All children MUST EXIT the water park before deflation or draining water.
2. Turn off the air pump motor and unplug it from the outlet.
3. Move the air pump to dry ground if it appears that it will get wet from draining water.

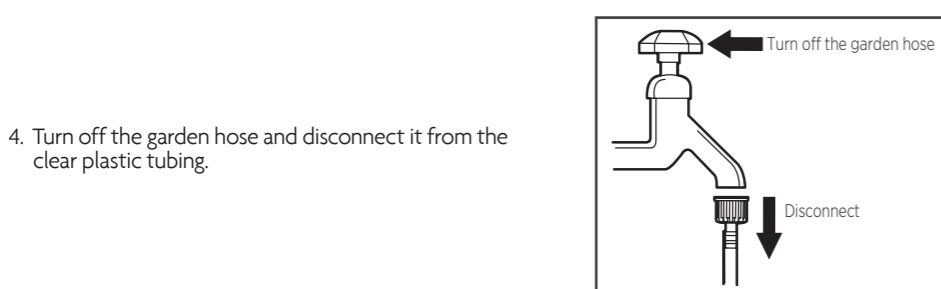
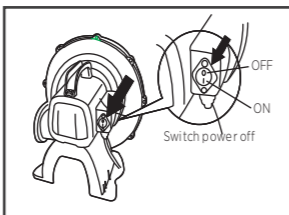

5. As the water park deflates, the water will find the lowest point and drain from the collapsing pool walls.
6. Lift the bottom of pool from one side to the other to let the remaining water drain.

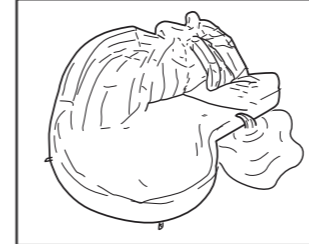

7. Remove stakes and move the water park away from the drained water to a dry area.

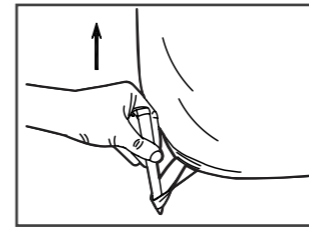

8. Re-stake the water park and air pump, then tie the inflation tube to the air pump and reconnect and power up the air pump.

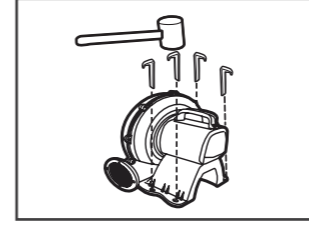

9. Leave the water park inflated until all remaining water has evaporated and it is completely dry. This may take two (2) hours or more depending on weather conditions.

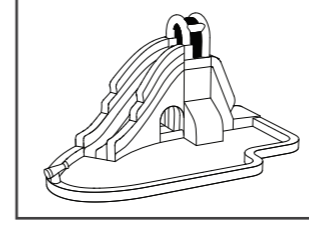

10. Once the water park is completely dry, turn off the air pump and motor, then unplug it from the outlet.

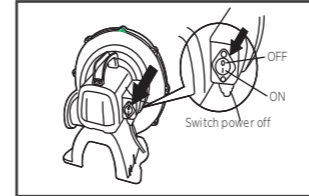

11. Remove and drain the hose assembly from the water park.
12. Untie the drawstring from the short outlet tube and allow the water park to fully deflate.
13. Remove the hose assembly and wrap it up carefully to avoid any kinks.

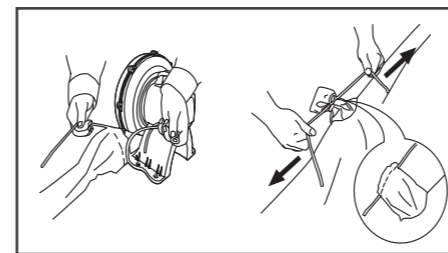

Care and Maintenance

Storage

NOTE: The water park MUST be drained of all water and be COMPLETELY DRY before storing in order to avoid mold and mildew.

1. Fold the sides of the deflated water park in toward the center.
2. Roll the water park tightly, letting out air as you roll.
3. Store the rolled-up water park in the included carrying case.

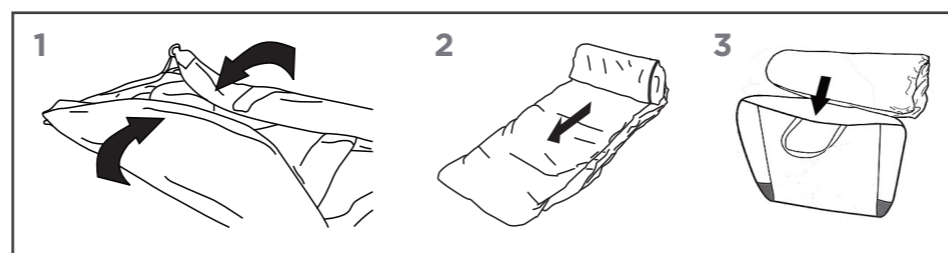

General Maintenance

- DO NOT fold and store the water park if any moisture remains on any part.
- As an outdoor product, the water park is subject to wear and deterioration. Regularly inspect for signs of fabric failure; weak or torn surfaces must be repaired promptly.
- To keep the product clean: wipe the water park and air pump using a dry cloth or a cloth dampened with pure water or a neutral, non-flammable, nontoxic cleaning and sanitizing solution.
- Product should never be stored while wet. Allow to dry before rolling up.

Using the Repair Kit

A repair kit has been provided for you in case of any punctures, featuring multiple repair patches and a sewing kit. Instructions for using your repair kit are as follows:

1. Locate a patch that matches the relative size and shape of the hole/puncture.
2. Cut the patch as needed to fit.
3. Make sure the water park is fully deflated.

4. Sew around the edges of the patch with strong thread or fishing line to secure it.
NOTE: You can use glue or similar adhesive to affix the patch, but in many cases, this is a short-term fix only. The best way to fix the hole is by sewing one of the included patches over the puncture.

Air Pump Maintenance

- The air pump must be unplugged before performing any maintenance.
- If the supply cord is damaged, it must be replaced by qualified persons in order to avoid a hazard.
- Product should be periodically examined for potentially unsafe conditions such as damaged cord, plug, housing, or parts. In the event such damage is found, the product should not be used until properly repaired. If these checks are not carried out, the product could overturn or otherwise become a hazard.
- The air pump does not require any lubrication and has no user serviceable parts. Do not attempt to service the air pump.
- Do not immerse the fan in water.
- To clean, wipe with a damp cloth.
- Regularly check the intake and output openings and keep them free of dirt, leaves, etc.
- When not in use, store the air pump indoors in a dry place.
- Store the air pump upright on a stable surface.
- Loosely coil the cord and place it beside the blower.
- Place the air pump in an area where it will not draw in dirt or leaves.

Disposal Instructions

- Disassemble and dispose of the equipment in such a manner that no hazardous conditions exist at the time the equipment is discarded.
- Air pump should be returned to a collection center.

Questions or concerns? We want to hear from you!

info@supportcbp.com
833-217-4422

Distributed by
C&A Marketing, Inc.
114 Tived Lane East
Edison, NJ 08837 USA

Made in China
SUNNY & FUN is a trademark of
C&A IP Holdings, LLC in the U.S.
©2020 All rights reserved

All other products, brand names, company names, and logos are trademarks of their respective owners, used merely to identify their respective products, and are not meant to connote any sponsorship, endorsement or approval.